

Orion

CE UK CA IP20

220-240V, 50/60Hz

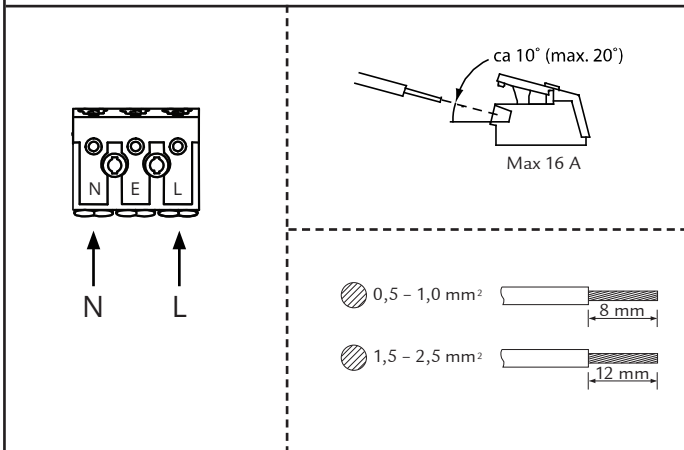
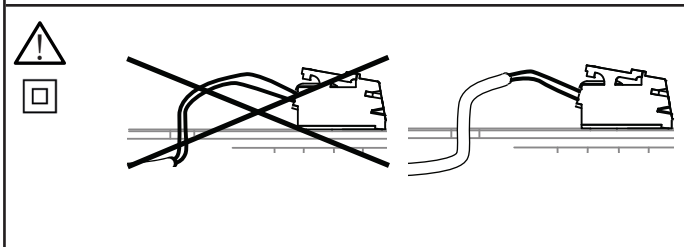
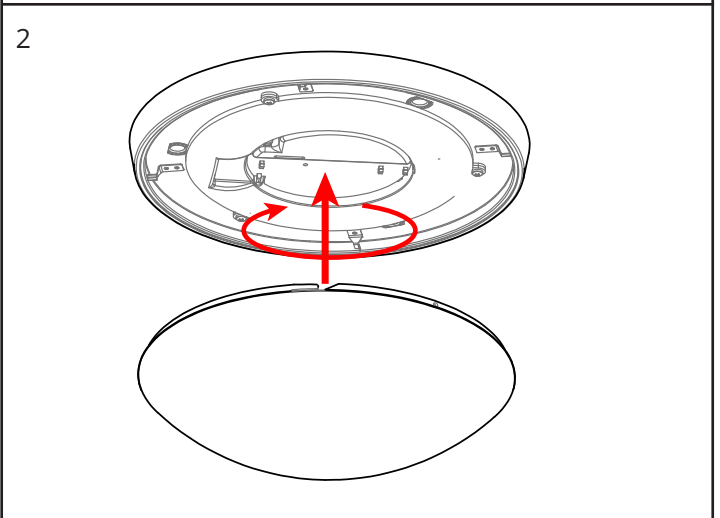
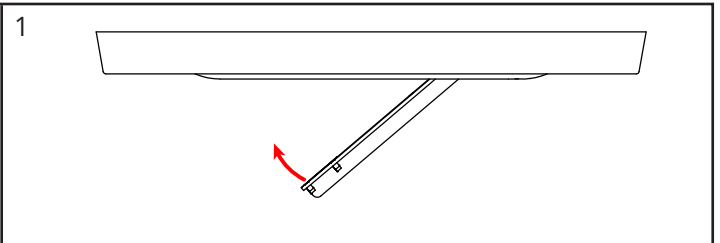
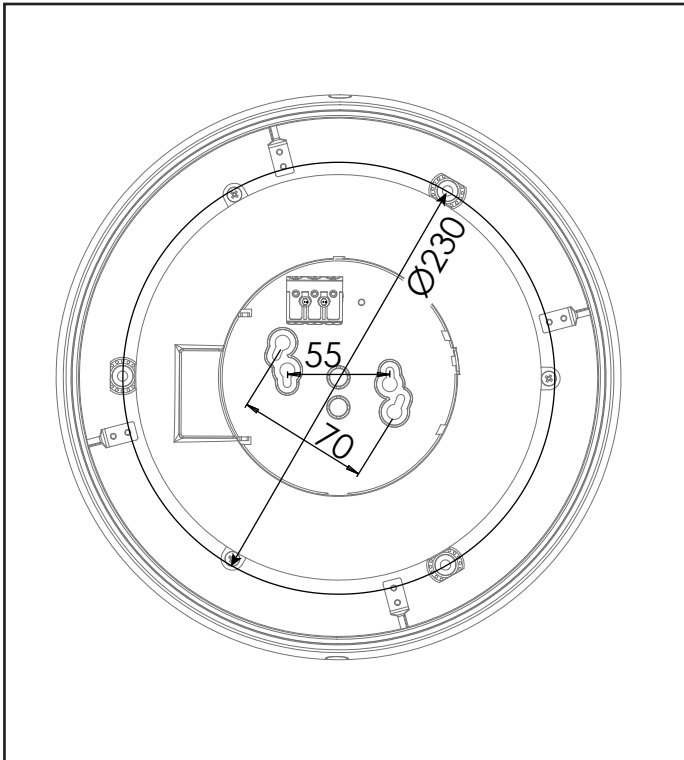

NO: Kan kun installeres og vedlikeholdes av en registrert installasjonsvirksomhet.
DK: Må kun installeres og vedlikeholdes af uddannet elektriker.
SE: Skall installeras och underhållas av behörig elektriker.
EN: Only to be installed and maintained by an authorized electrician.
FR: Doit être installé et maintenu par un électricien qualifié.
NL: Mag alleen geïnstalleerd en onderhouden worden door een bevoegde electricien.
DE: Dieses Produkt darf nur durch autorisiertes Personal (z.B. Elektro-Installateur) angeschlossen, in Betrieb genommen und gewartet werden.
FI: Asentaa ja huoltaa saa vain valtuutettu sähköasentaja

NO: Skru av strømmen før montering.
DK: Sluk for strømmen inden montering.
SE: Stäng av strømmen innan montering.
EN: Turn off power before installing.
FR: Couper le courant avant l'installation.
NL: Stroom uitschakelen voor u het toestel installeert.
DE: Vor Installationsarbeiten den Strom abschalten.
FI: Sammuta virta ennen kytkemistä

Rev: 21.03.2022

NORWAY
 SG Armaturen AS
 Skytterheia 25
 N-4790 Lillesand

SWEDEN
 SG Armaturen AB
 Tel: +46 31 81 71 10
 info@sg-ab.se
 www.sg-ab.se

DENMARK
 SG Armaturen A/S
 Tel: +45 70 70 72 13
 info@sg-as.dk
 www.sg-as.dk

FRANCE
 SG Lighting SA/NV
 Tel: +33(0) 4 94 93 00 00
 info.france@sglighting.fr
 www.sglighting.net

GERMANY
 SG Leuchten GmbH
 Tel: +49 40 23 99 44 59
 info@sg-leuchten.de
 www.sg-leuchten.de

Tel: +47 37 50 03 00
 firmapost@sg-as.no
 www.sg-as.no

FINLAND
 SG Armaturen Oy
 Tel: +358 02 07 30 39 60
 info@sg-oy.fi
 www.sg-oy.fi

UNITED KINGDOM
 SG Lighting LTD
 Tel: +47 37 50 03 00
 info@sglighting.co.uk
 www.sglighting.co.uk

BENELUX
 SG Lighting SA/NV
 Tel: +32(0) 15 20 72 71
 info.benelux@sglighting.net
 www.sglighting.net

INTERNATIONAL
 SG Lighting Co Ltd.
 Tel: +86 769 88 49 20 88
 cindy@sgdgc.com
 www.sg-as.com

Motion and daylight sensor



Push

		1	2
Hold time	10 minutes	1	1
	5 minutes	0	1
	1 minute	1	0
	5 seconds	0	0

		3	4
Motion sensitivity	High	1	1
	Medium	0	1
	Low	1	0
	Off	0	0

		5	6
Daylight sensitivity	Low	1	1
	Medium	0	1
	High	1	0
	Off	0	0

		7
Midnight cut	On	1
	Off	0

		8
Basic light	On	1
	Off	0

No Push

Hold time

	1	2
10 min	1	1
5 min	0	1
1 min	1	0
5 sec	0	0

Rev: 17.2.2020

NORWAY
SG Armaturen AS

Skytterheia 25
N-4790 Lillesand

Tel: +47 37 50 03 00
firmapost@sg-as.no
www.sg-as.no

SWEDEN

SG Armaturen AB
Tel: +46 31 81 71 10
info@sg-ab.se
www.sg-ab.se

FINLAND

SG Armaturen Oy
info@sg-oy.fi
www.sg-oy.fi

DENMARK

SG Armaturen A/S
Tel: +45 70 70 72 13
info@sg-as.dk
www.sg-as.dk

UNITED KINGDOM

SG Lighting LTD
Tel: +47 37 50 03 00
info@sglighting.co.uk
www.sglighting.co.uk

FRANCE

SG Lighting SA/NV
Tel: +33(0) 4 94 93 00 00
info.france@sglighting.fr
www.sglighting.net

BENELUX

SG Lighting SA/NV
Tel: +32(0) 15 20 72 71
info.benelux@sglighting.net
www.sglighting.net

GERMANY

SG Leuchten GmbH
Tel: +49 40 23 99 44 59
info@sg-leuchten.de
www.sg-leuchten.de

INTERNATIONAL

SG Lighting Co Ltd.
Tel: +86 769 88 49 20 82
cindy@sgdgc.com
www.sg-as.com

Motion sensitivity

	3	4
High	1	1
Medium	0	1
Low	1	0
Off	0	0

1

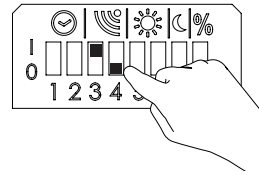

2

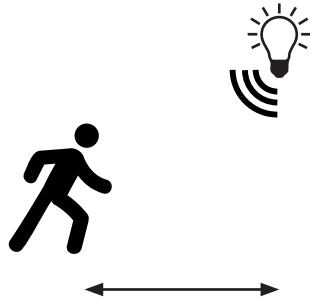
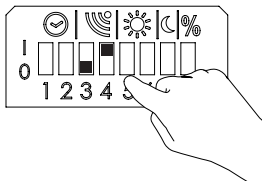

3

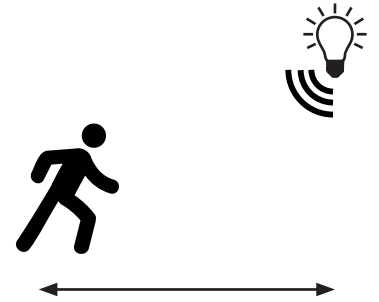
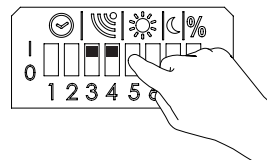

Daylight sensitivity

	5	6
Low	1	1
Medium	0	1
High	1	0
Off	0	0

1

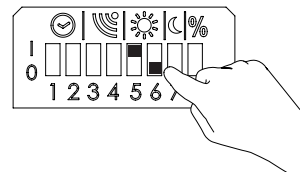

2

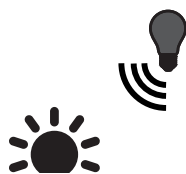
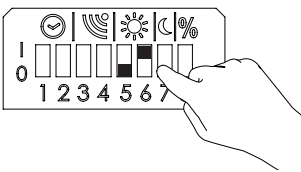

3

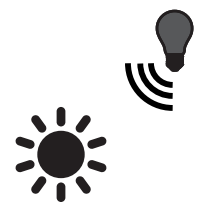
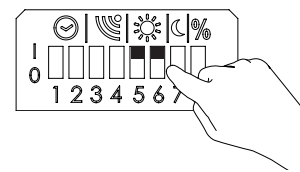

Midnight cut

~00:00 - 05:00 AM

~00:00 - 05:00 AM

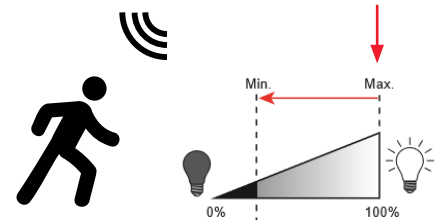
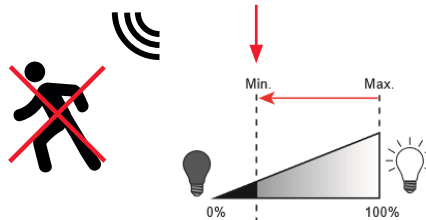
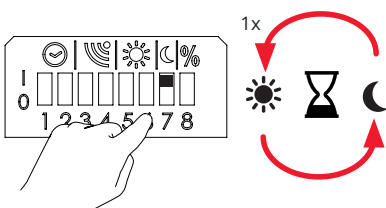

Light levels -
Basic light and max light

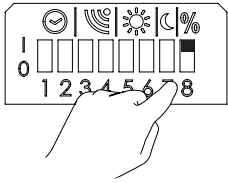

1

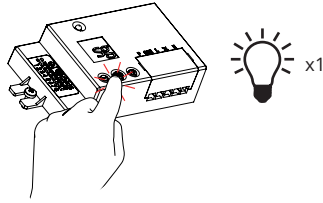

2

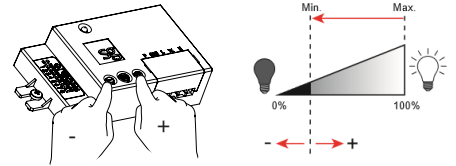

Basic light

3

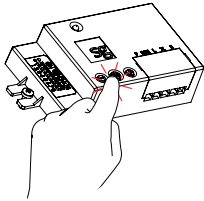

4

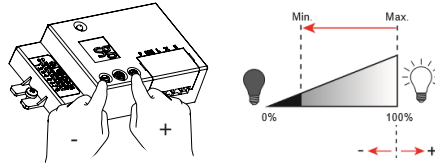

Maximum light level

5

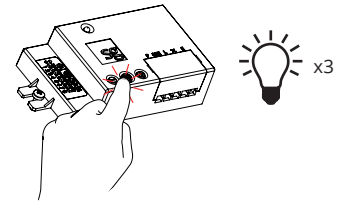

Light levels - Midnight cut

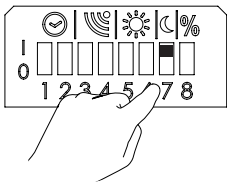

1

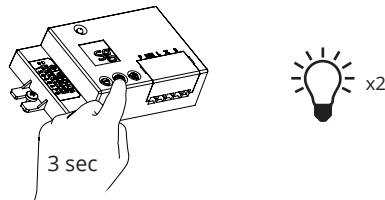

2

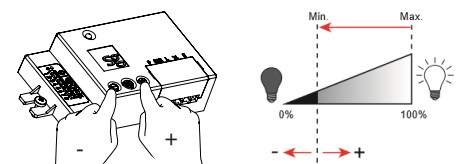

Minimum midnight cut

3

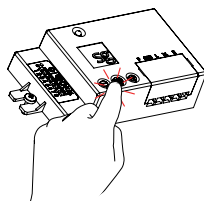

4

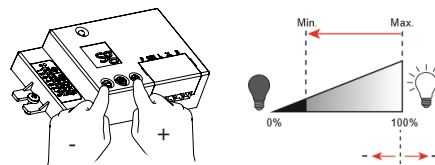

Maximum midnight cut

5

